

# UBIQUA

Design T. Colzani

LIBRERIA MODULARE | MODULAR BOOKCASE



# UBIQUA

Design T. Colzani

## LIBRERIA MODULARE | MODULAR BOOKCASE

Libreria modulare con colonne portanti e fissaggio a soffitto o a parete. È possibile personalizzare la composizione attraverso mensole, cassettiere e contenitori.

*Modular bookcase with columns to be fixed to the wall or to the ceiling. It is possible to customize the composition with shelves, chests of drawers and containers.*

*Mudaleres Bücherregal mit Säulen, welche an der Wand, oder Decke befestigt werden können. Es sind personalisierte Kompositionen mit Fachböden, Kommoden und Container.*

*Bibliothèque modulaire avec colonnes et fixation au plafond ou au mur. Possibilité de personnaliser la composition avec étagères, commodes et containers.*

*Librería modular con columnas con fijación a la pared o al techo. Es posible personalizar la composición con repisas, cajoneras y contenedores.*



## COMPOSIZIONI A SOFFITTO | CEILING COMPOSITIONS

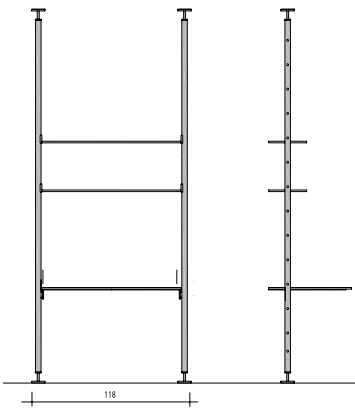

COMP. U48

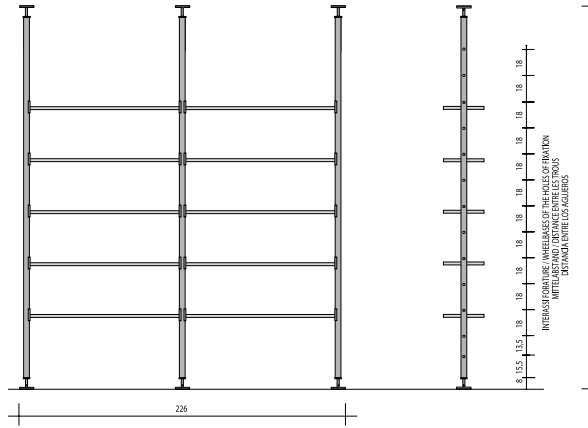

COMP. U15

ALTEZZA ESTERNA MASSIMA / TOTAL HEIGHT CM. 108  
 MAX. EXTERNAL HEIGHT / MAX. TOTAL HEIGHT CM. 108  
 ALTEZZA ESTERNA MINIMA / CM. 317

INTERASSI POSITIVE / POSITIVE SPACINGS BETWEEN HOLES OF FIXATION  
 MITTELABSTAND / DISTANCE BETWEEN HOLES OF FIXATION  
 DISTANCIA ENTRE LOS AGUJEROS

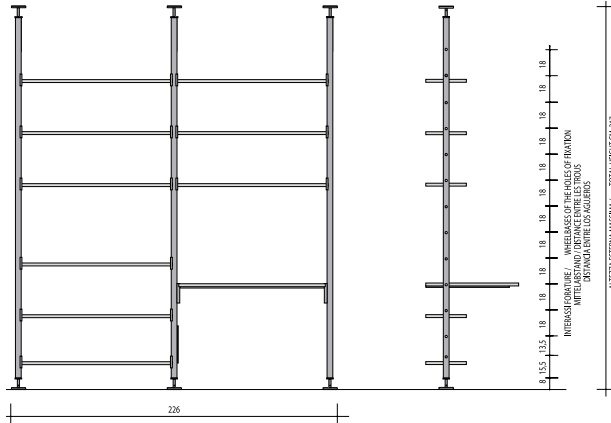

COMP. U33

ALTEZZA ESTERNA MASSIMA / TOTAL HEIGHT CM. 108  
 MAX. EXTERNAL HEIGHT / MAX. TOTAL HEIGHT CM. 108  
 ALTEZZA ESTERNA MINIMA / CM. 317

INTERASSI POSITIVE / POSITIVE SPACINGS BETWEEN HOLES OF FIXATION  
 MITTELABSTAND / DISTANCE BETWEEN HOLES OF FIXATION  
 DISTANCIA ENTRE LOS AGUJEROS

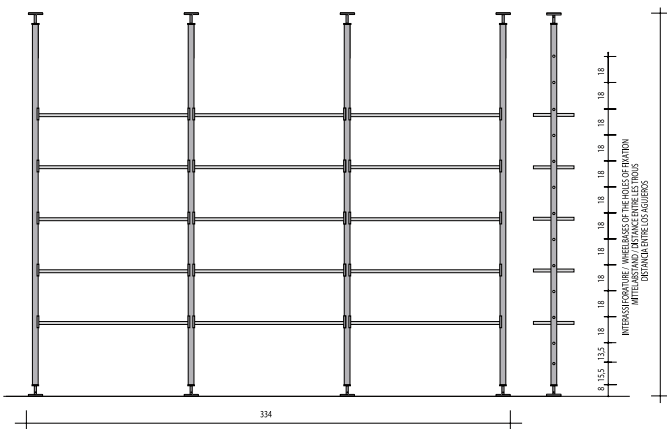

COMP. U46

ALTEZZA ESTERNA MASSIMA / TOTAL HEIGHT CM. 108  
 MAX. EXTERNAL HEIGHT / MAX. TOTAL HEIGHT CM. 108  
 ALTEZZA ESTERNA MINIMA / CM. 317

INTERASSI POSITIVE / POSITIVE SPACINGS BETWEEN HOLES OF FIXATION  
 MITTELABSTAND / DISTANCE BETWEEN HOLES OF FIXATION  
 DISTANCIA ENTRE LOS AGUJEROS

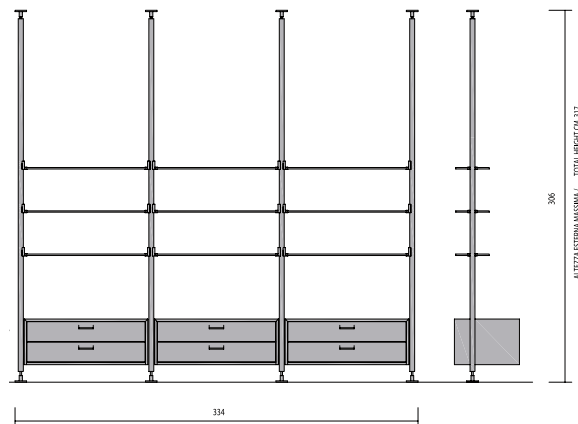

COMP. U50

ALTEZZA ESTERNA MASSIMA / TOTAL HEIGHT CM. 108  
 MAX. EXTERNAL HEIGHT / MAX. TOTAL HEIGHT CM. 108  
 ALTEZZA ESTERNA MINIMA / CM. 317

306

## COMPOSIZIONI A PARETE | WALL COMPOSITIONS

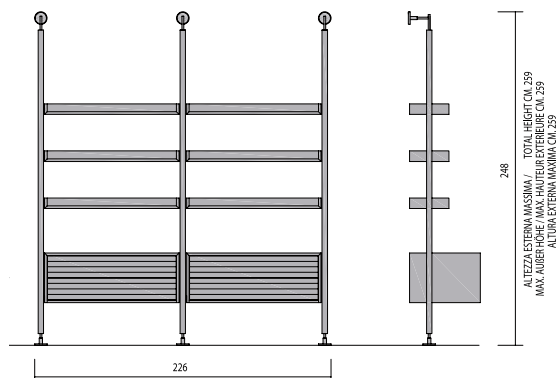

COMP. U52

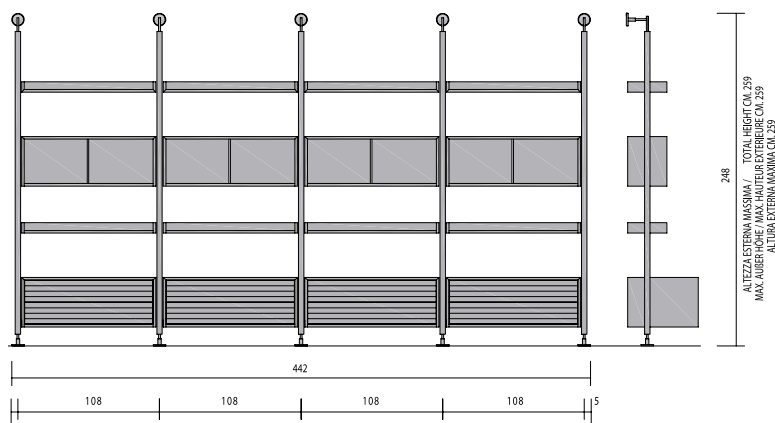

COMP. U51

## COMPOSIZIONI A SOFFITTO GIREVOLI | SWIVELING CEILING COMPOSITIONS

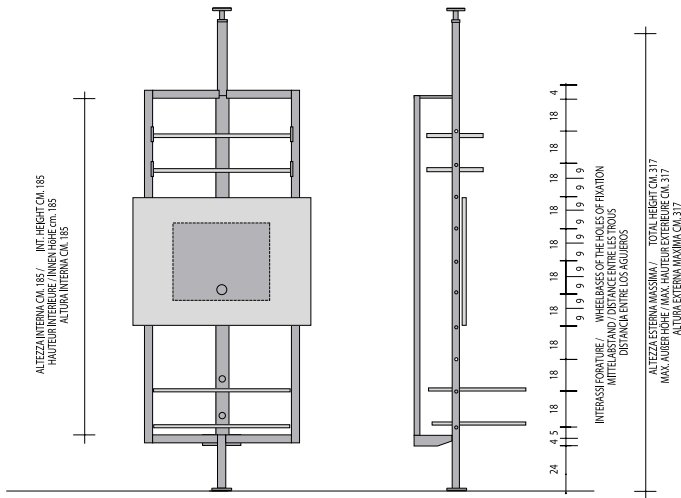

COMP. U43

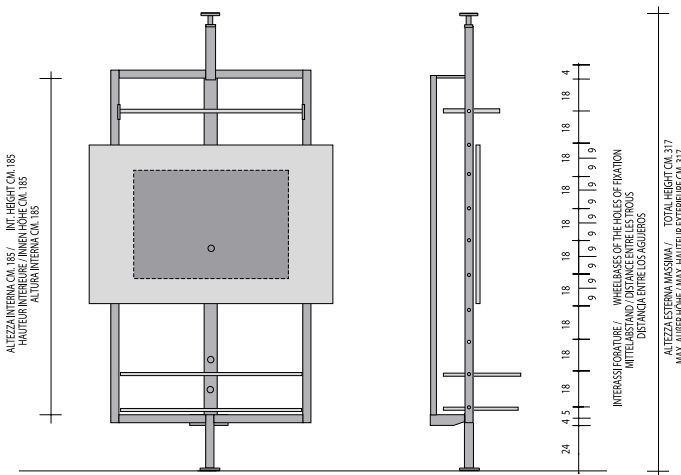



## COMPOSIZIONI AUTOPORTANTI | FREESTANDING COMPOSITIONS

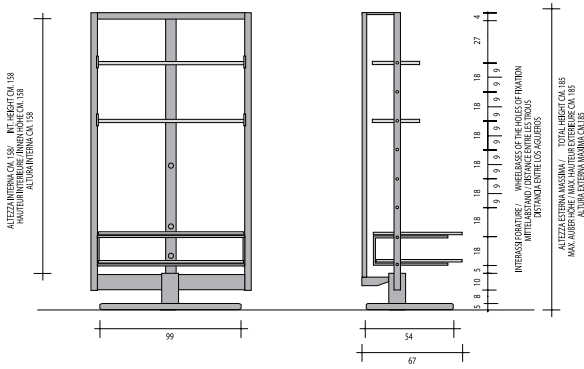

COMP. U27

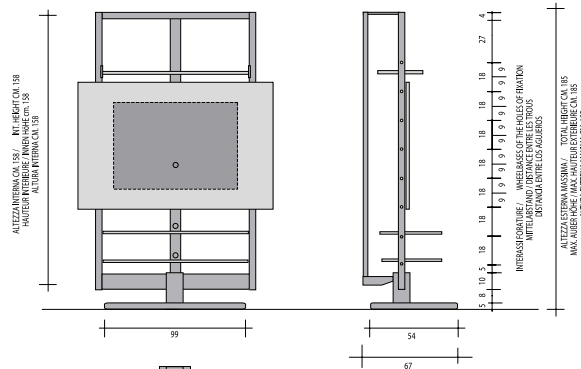

COMP. U41

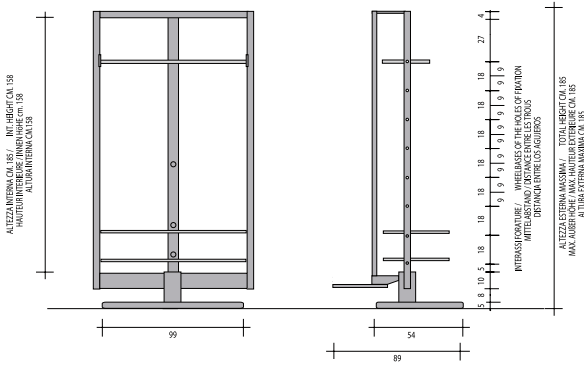

COMP. U42

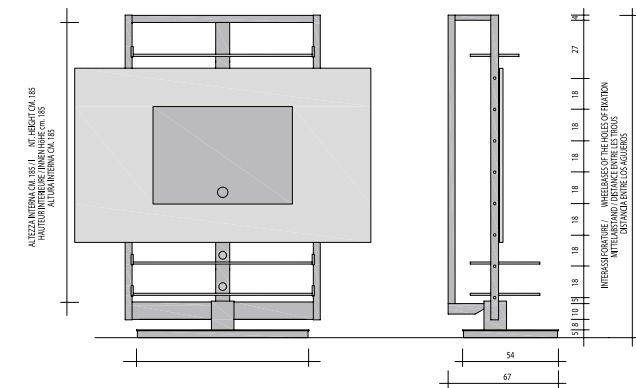

COMP. U47

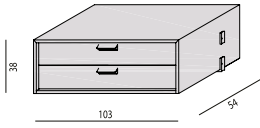

**CASSETTIERA IN CUOIO**  
*Leather Chest of Drawers*  
cm. 103x54

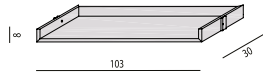

**MENSOLA IN LEGNO**  
*Wooden Shelf*  
cm. 103x30

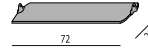

**MENSOLA IN CRISTALLO**  
*Glass Shelf*  
cm. 72x28

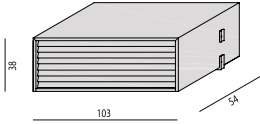

**CASSETTIERA IN LEGNO**  
*Wooden Chest of Drawers*  
cm. 103x54

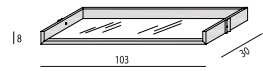

**MENSOLA IN CRISTALLO**  
*Glass Shelf*  
cm. 103x30

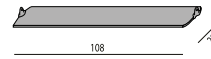

**MENSOLA IN CRISTALLO**  
*Glass Shelf*  
cm. 108x28

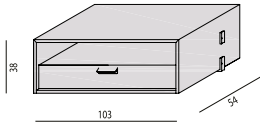

**MOBILE A GIORNO IN CUOIO**  
*Leather container with open compartment*  
cm. 103x54

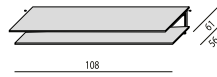

**PIANO TV IN CRISTALLO**  
*Glass TV-Shelf*  
cm. 108x61

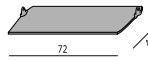

**MENSOLA IN CRISTALLO**  
*Glass Shelf*  
cm. 72x40

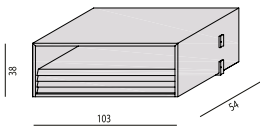

**MOBILE A GIORNO IN LEGNO**  
*Wooden container with open compartment*  
cm. 103x54

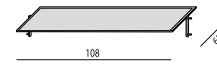

**PIANO SCRITTOIO IN CRISTALLO**  
*Glass Writing Desk*  
cm. 108x61

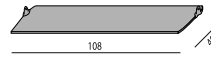

**MENSOLA IN CRISTALLO**  
*Glass Shelf*  
cm. 108x40

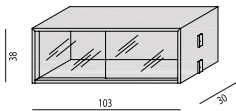

**VETRINA**  
*Cabinet*  
cm. 103x30



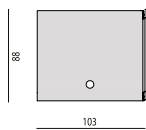

**PANNELLO PORTA TV IN LEGNO**  
*Wooden board for flat TV*  
 cm. 103

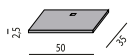

**PORTA SUB-WOOFER**  
*Sub-woofer Holder*

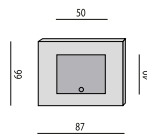

**PANNELLO PORTA TV IN CRISTALLO**  
*Glass board for flat TV*  
 cm. 72

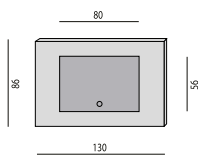

**PANNELLO PORTA TV IN CRISTALLO**  
*Glass board for flat TV*  
 cm. 130

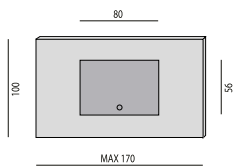

**PANNELLO PORTA TV IN CRISTALLO**  
*Glass board for flat TV*  
 cm. 170

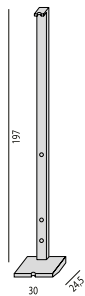

**PORTA CAVI**  
*Channel for cables*

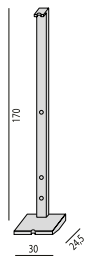

**PORTA CAVIPER AUTOPORTANTE**  
*Channel for cables for freestanding column*

## LIBRERIA MODULARE | MODULAR BOOKCASE

### Essenze | Wood



NOCE CANALETTA  
Canaletta Walnut

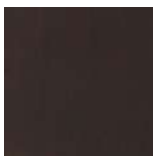

NOCE CANALETTA  
Canaletta Walnut  
tinto/stained moka

### Laccato opaco poro chiuso | Matt Lacquered closed pore

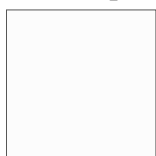

BIANCO  
White  
(RAL 9016)



AVORIO  
Ivory  
(RAL 1013)



ARGILLA  
Argilla  
(RAL 7006)



PIOMBO  
Piombo  
(NCS S5005G20Y)



NERO  
Black  
(RAL 9005)



GRANATA  
Granata  
(NCS S4050Y90R)



PISTACCHIO  
Pistacchio  
(PANTONE 5825)

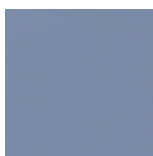

AVIO  
Avio  
(PANTONE 5415)

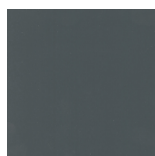

IRON  
Iron  
(RAL 7011)



CIOCCOLATO  
Chocolate  
(RAL 8019)

### Cuoietto | Cuoietto Leather

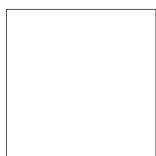

BIANCO  
White



NERO  
Black



TESTA DI MORO  
Testa di Moro



BULGARO  
Bulgaro Red



NATURALE  
Natural

### Metallo | Metal

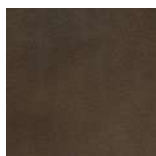

BRONZORO