



Sedia con braccioli e struttura in massello di noce canaletta o frassino e rivestimento nei tessuti della collezione. Possibilità di ordinare schienale e bottoni tono su tono o in contrasto.

Chair with arms with frame in solid canaletta walnut or ash wood and cover in the fabrics of the collection. The buttons could be ton sur ton or in contrast.

Armlehnstuhl mit Gestell aus massivem Nussbaum Canaletta oder Esche und Bezug in den Stoffen der Kollektion. Mit der Möglichkeit die Rückenissen und Knöpfe in der selben oder zwei verschiedenen Stofffarben zu wählen.

Chaise avec accoudoirs avec structure en noyer canaletta oder frêne massif et revêtement dans les tissus de la collection. Le dossier et les boutons peuvent être ton sur ton ou en contraste.

Silla con brazos y estructura en nogal canaletta o fresno macizo y revestimiento en las telas de la colección. Botones en la misma tela del asiento o en contraste.

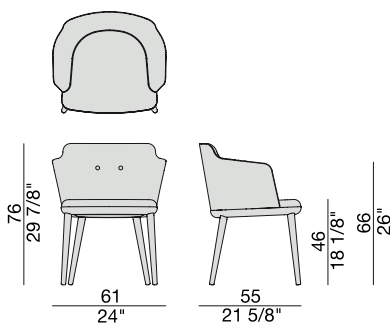

ESSENZE | *Essences*



Noce Canaletta
Canaletta Walnut



Noce Canaletta
Canaletta Walnut
tinto/stained moka



Noce Canaletta
Canaletta Walnut
tinto/stained wengé



Frassino Naturale
Natural Ash



Frassino
Ash
tinto/stained moka



Frassino
Ash
*tinto noce canaletta
canaletta walnut stained*



Frassino
Ash
tinto/stained wengé

LACCATO OPACO PORO CHIUSO | *Matt lacquered closed pore*

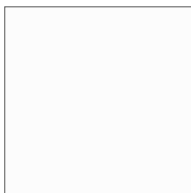

Bianco
White
(RAL 9016)

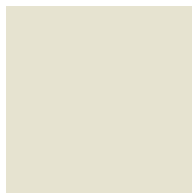

Avorio
Ivory
(RAL 1013)



Argilla
Mud
(RAL 7006)



Piombo
Lead
(NCS S5005G20Y)



Cioccolato
Chocolate
(RAL 8019)

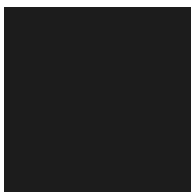

Nero
Black
(RAL 9005)

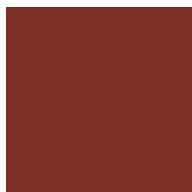

Granata
Garnet red
(NCS S4050Y90R)



Pistacchio
Pistachio green
(PANTONE 5825)



Avio
Aviation blue
(PANTONE 5415)

LACCATO OPACO PORO APERTO | *Matte lacquered open pore*



Bianco
White
(RAL 9016)

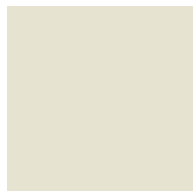

Avorio
Ivory
(RAL 1013)



Argilla
Mud
(RAL 7006)



Piombo
Lead
(NCS S5005G20Y)



Cioccolato
Chocolate
(RAL 8019)

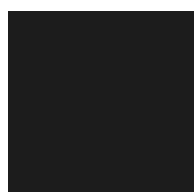

Nero
Black
(RAL 9005)



Granata
Garnet red
(NCS S4050Y90R)



Pistacchio
Pistachio green
(PANTONE 5825)



Avio
Aviation blue
(PANTONE 5415)

PELLE | *Leather*

Categoria LUX



Nabuk
2107

Categoria PLUS



Pelle PLUS
35

Categoria PELLE



Pelle
D58

Categoria EXTRA

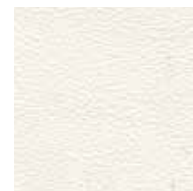

Pelle EXTRA
L 635

RIVESTIMENTO | *Cover*

Categoria A

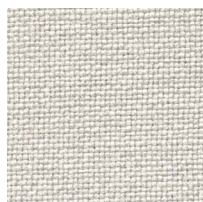

Hallingdal 65

Categoria B



Rabat

Categoria C



Fashion



Moran



Thalys



Velvet



Wool

Categoria D



Astra



Ecopelle



Range



Tress

Categoria E

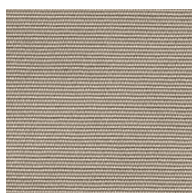

Cotone



Dorian



In Bianco/Calico

Categoria COM

Disponibile con tessuto fornito dal cliente. Tessuto richiesto cm. 170 x 140.

Available with fabric supplied by the customer. Fabric needed cm 170 x 140.

Verfügbar mit Kundenstoff cm. 170 x 140.

Disponible avec tissu du client cm. 170 x 140.

Disponibile con tela suministrada por el cliente. Tela necesaria cm. 170 x 140.